

40
CHANNELS

OLED display
8 bit / 16 bit
4 kinds of DMX interfaces
Dimming curve: 0.1-9.9
Short circuit / Over current / Overheat protection

D40

DMX512 DECODER

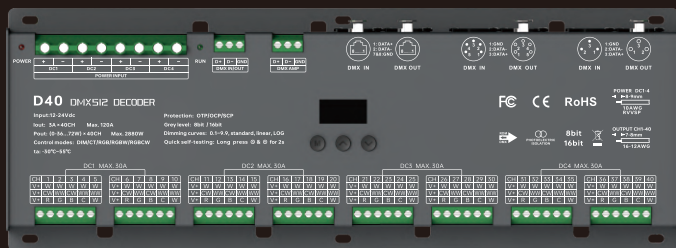

Product introduction

- 1、 Designed for Hi-power multiple channels application, 40 channels output, and Max. 3A current per channel, up to 2880W output power.
- 2、 The human-computer interaction interface is composed of an OLED screen and 3 buttons, which displays rich content and is simple and fast to operate.
- 3、 The number of DMX channels can be set to CH01/CH02/CH03/CH04/CH05/CH08/CH16/CH24/CH32/CH40, which can realize independent address independent channel control, or one address to control multiple channels.
- 4、 The PWM frequency can be set to 300/600/1200/1500/1800/2400/3600/7200/10800/14400/18000Hz;
- 5、 3-pin XLR, 5-pin XLR, RJ45 and green terminal DMX interface with photoelectric isolation, improve signal transmission efficiency and anti-interference ability, the green terminal also has signal amplifier function.
- 6、 With the operations can be completed via the RDM master console, such as parameters browsing & settings, DMX address settings, equipment recognition, etc.
- 7、 DMX master control mode;
- 8、 With firmware upgrade function.
- 9、 With short circuit, over current and over temp. protection, as well as warning function when a fault occurs.
- 10、 With power-on state management and fast self-testing function.
- 11、 16bit (65536 levels) / 8bit (256 levels) grey level available.
- 12、 Available for standard, linear, LOG or custom 0.1-9.9 dimming curve.
- 13、 The device has 10 built-in personalized lighting effects. You can enter the setting interface of the DMX master mode and select different lighting effects to achieve precise output control of other decoders.
- 14、 Parameters can be set and modified through the RDM master control or mobile phone APP, eliminating the need for high-altitude operations.

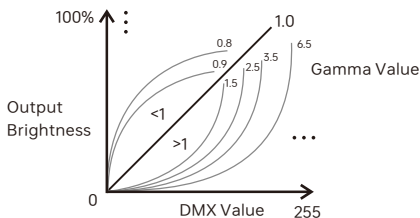

3-pin XLR



5-pin XLR



RJ45



RDM



Photoelectric
isolation



Short circuit
protection



Overheat
protection



Over current
protection



Display

Technical specs

Model :	D40
Input signal :	DMX512/RDM
Input voltage :	12- 24Vdc
Current load :	3A×40CH Max. 120A
Output power :	(0~36W...72W)×40CH Max. 2880W
DMX interfaces :	3-pin XLR, 5-pin XLR, RJ45, Green terminal
Number of DMX channels :	CH01, CH02, CH03, CH04, CH05, CH08, CH16, CH24, CH32, CH40
Dimming curves :	0.1~9.9, standard, linear, LOG
Grey level :	8bit (256 levels) / 16bit (65536 levels)
Photoelectric isolation :	Yes
Protection:	Short circuit / Overheat / Over current protection, recover automatically
Working temperature :	-30°C-55°C
Dimensions :	L340×W122×H42.5mm
Package size :	L350×W149×H47.5mm
Weight (G.W.):	1220g



Product size

Unit: mm

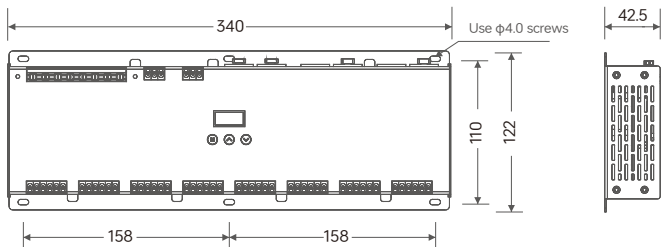

Main component description

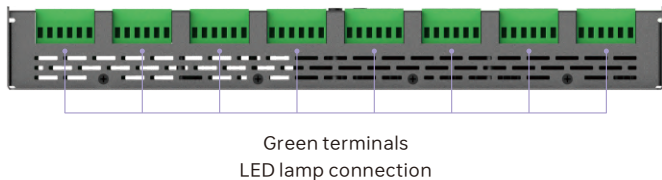
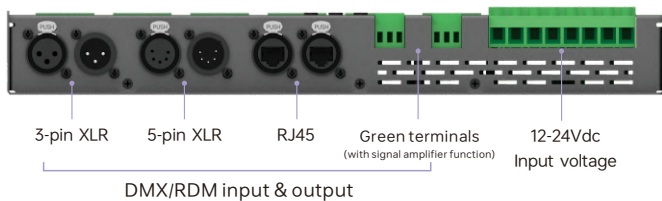
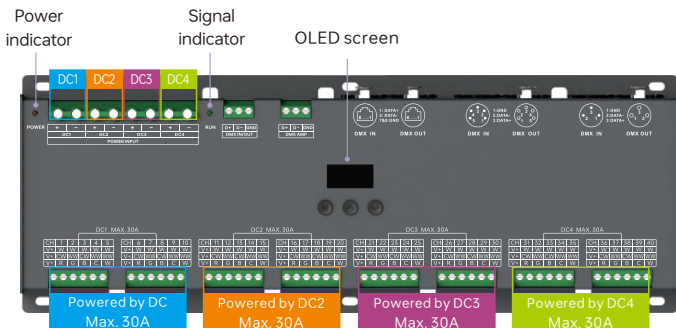

OLED screen interface

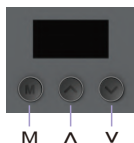

Press "M" key, switch entries.
Long press "M" key, back to main page.
Press "^" or "v" key, parameter adjustment.
Exit: back to previous page.

1、DMX address settings

DMX: 001 Hz: Std
Mode: CH01 8bit
Curve: Standard
Dim: Smo TOOL&v

Main page

Press "^" or "v" key to set DMX address.
Range: 001~512, Default display 001

2、PWM frequency

DMX: 001 Hz: Std
Mode: CH01 8bit
Curve: Standard
Dim: Smo TOOL&v

Press M and press "^" or "v" key to select
Available:

300Hz 600Hz 1200Hz
1500Hz 1800Hz 2400Hz
3600Hz 7200Hz 10800Hz
14400Hz 18000Hz Std(acquiesce)

3、Number of DMX channels

DMX: 001 Hz: Std
Mode: CH01 8bit
Curve: Standard
Dim: Smo TOOL&v

Press M and press "^" or "v" key to select

Available:

CH01、CH02、CH03、CH04、CH05、
CH08、CH16、CH24、CH32、CH40(acquiesce)

* For details on the specific number of channel settings,
please see P10-P13.

4、Grey scale

DMX: 001 Hz: Std
Mode: CH01 8bit
Curve: Standard
Dim: Smo TOOL&v

Press M and press "^" or "v" key to select

Available: 8bit, 16bit, 8bit(acquiesce)

5、Dimming curves

DMX: 001 Hz: Std
Mode: CH01 8bit
Curve: Standard
Dim: Smo TOOL&v

Press M and press "^" or "v" key to select

Available: Standard

Linear
Log
0.1~9.9

* It is recommended to use standard,
0.1~9.9 is for special requirements.

6、Enhance dimming

```
DMX: 001 Hz: Std
Mode: CH01 8bit
Curve: Standard
Dim: Smo TOOL&v
```

Press M and press "∧" or "∨" key to select

Available: Std (standard)
Smo (smooth)

★ It is recommended to use standard.

Smo: This option with smooth processing, realizes flicker-free dimming and smooth dynamic effects.

7、Tool

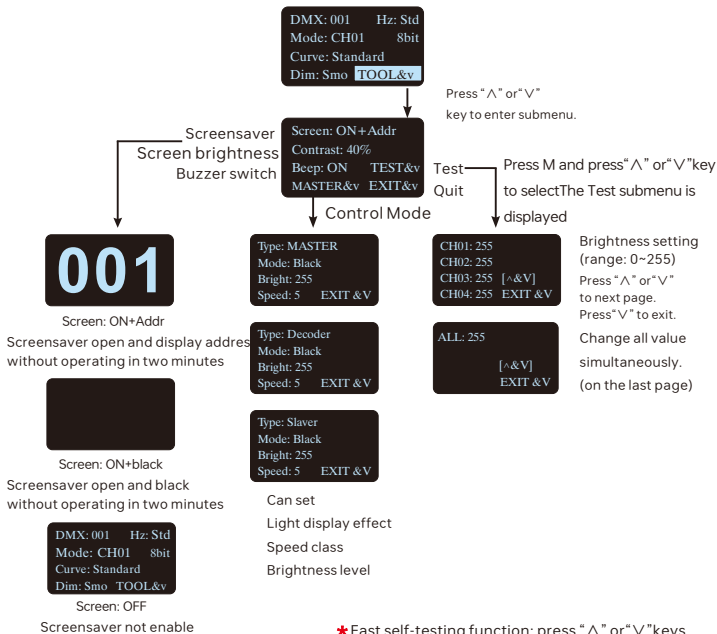

★ Fast self-testing function: press "∧" or "∨" keys simultaneously for 2-3 seconds under any page, decoder will enter self-testing function

Wiring diagram

1. Connecting LED lights:

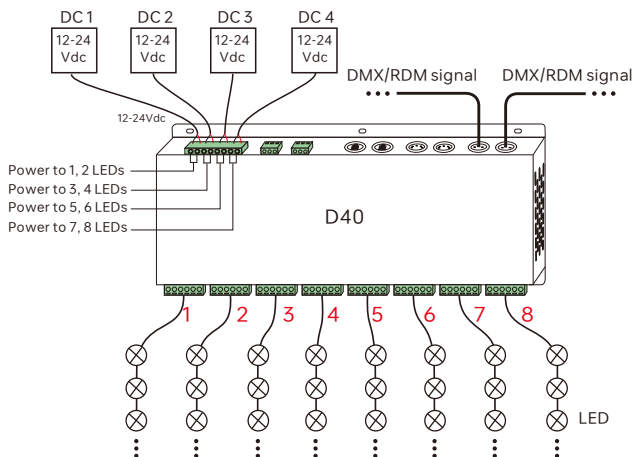

Dimming mode

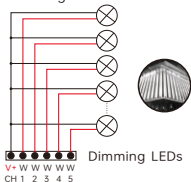

CT mode

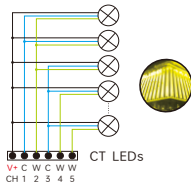

RGB mode

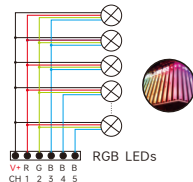

RGBW mode

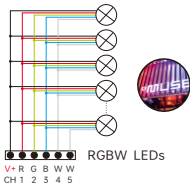

RGBCW mode

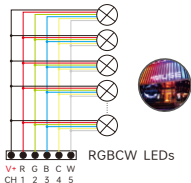

2. DMX Decoder Mode

D40 is equipped with DMX terminals for users' selection. The following diagram takes 3-pin XLR as an example, same connecting method for the rest three: Rj45 & 5-pin XLR & green terminal (with amplifier function).

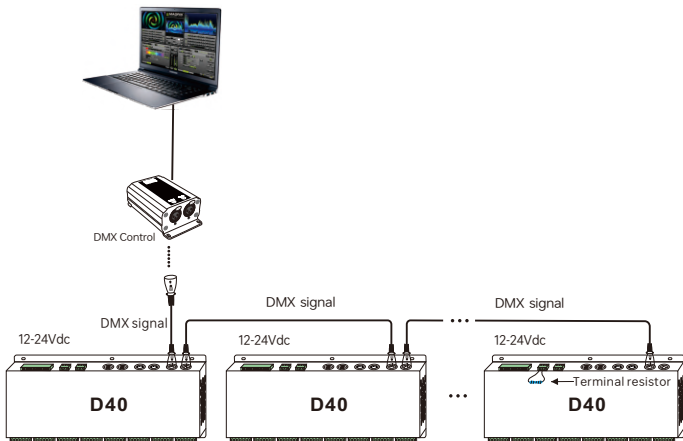

3. DMX Control Mode

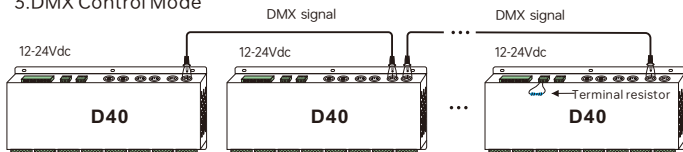

- * If the recoil effect occurs because of longer signal line or bad line quality, please try to connect 0.25W 90-120Ω terminal resistor at the end of each line.

4. The connection diagram of 4 kinds of DMX/RDM terminals:

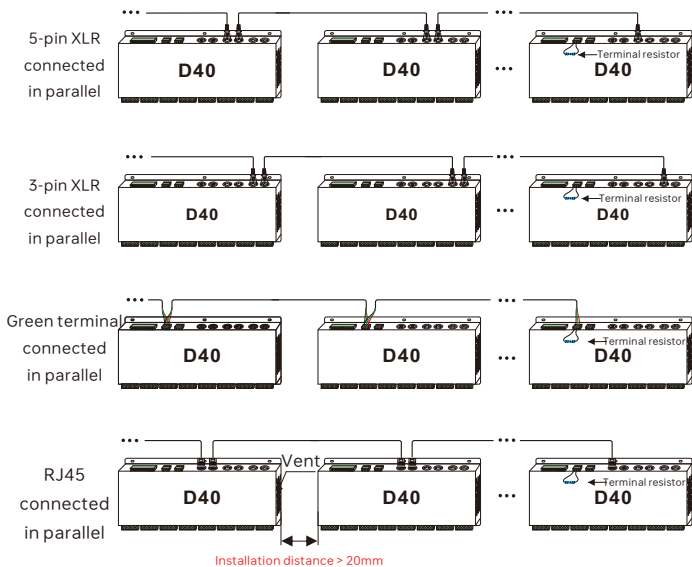

These 4 terminals can be connected in a mixed way.

*** Installation attentions:** Please reserve enough ventilation distance between decoders (>20mm), be sure not to block the vent, or it will affect lifetime of decoder for poor heat dissipation.

5. The connection diagram of AMP signal amplifier terminal:

*** Connecting with green terminal or an extra amplifier will be needed when more than 32 decoders are connected or use overlong signal wire (as shown below). Signal amplifier should not be more than 5 times continuously.**

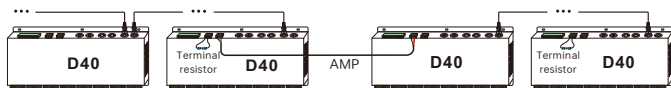

8bit Address setting table

Mode	DIM		CT		RGB		RGBW		RGBCW	
	CH01	CH08	CH02	CH16	CH03	CH24	CH04	CH32	CH05	CH40
Address quantity	1	8	2	16	3	24	4	32	5	40
Resolution	8bit	8bit	8bit	8bit	8bit	8bit	8bit	8bit	8bit	8bit
Channels	1	001	001	001	001	001	001	001	001	001
	2	001	001	002	002	002	002	002	002	002
	3	001	001	001	001	003	003	003	003	003
	4	001	001	002	002	003	003	004	004	004
	5	001	001	002	002	003	003	004	004	005
	6	001	002	001	003	001	004	001	005	001
	7	001	002	002	004	002	005	002	006	002
	8	001	002	001	003	003	006	003	007	003
	9	001	002	002	004	003	006	004	008	004
	10	001	002	002	004	003	006	004	008	005
	11	001	003	001	005	001	007	001	009	001
	12	001	003	002	006	002	008	002	010	002
	13	001	003	001	005	003	009	003	011	003
	14	001	003	002	006	003	009	004	012	004
	15	001	003	002	006	003	009	004	012	005
	16	001	004	001	007	001	010	001	013	001
	17	001	004	002	008	002	011	002	014	002
	18	001	004	001	007	003	012	003	015	003
	19	001	004	002	008	003	012	004	016	004
	20	001	004	002	008	003	012	004	016	005
	21	001	005	001	009	001	013	001	017	001
	22	001	005	002	010	002	014	002	018	002
	23	001	005	001	009	003	015	003	019	003
	24	001	005	002	010	003	015	004	020	004
	25	001	005	002	010	003	015	004	020	005

Mode	DIM		CT		RGB		RGBW		RGBCW		
	CH01	CH08	CH02	CH16	CH03	CH24	CH04	CH32	CH05	CH40	
Address quantity	1	8	2	16	3	24	4	32	5	40	
Resolution	8bit	8bit	8bit	8bit	8bit	8bit	8bit	8bit	8bit	8bit	
Channels	26	001	006	001	011	001	016	001	021	001	026
	27	001	006	002	012	002	017	002	022	002	027
	28	001	006	001	011	003	018	003	023	003	028
	29	001	006	002	012	003	018	004	024	005	029
	30	001	006	002	012	003	018	004	024	005	030
	31	001	007	001	013	001	019	001	025	001	031
	32	001	007	002	014	002	020	002	026	002	032
	33	001	007	001	013	003	021	003	027	003	033
	34	001	007	002	014	003	021	004	028	004	034
	35	001	007	002	014	003	021	004	028	004	035
	36	001	008	001	015	001	022	001	029	001	036
	37	001	008	002	016	002	023	002	030	002	037
	38	001	008	001	015	003	024	003	031	003	038
	39	001	008	002	016	003	024	004	032	004	039
40	001	008	002	016	003	024	004	032	005	040	

16bit Address setting table

Mode		DIM		CT		RGB		RGBW		RGBCW	
		CH01	CH08	CH02	CH16	CH03	CH24	CH04	CH32	CH05	CH40
Address quantity		2	16	4	32	6	48	8	64	10	80
Resolution		16bit	16bit	16bit	16bit	16bit	16bit	16bit	16bit	16bit	16bit
Channels	1	001 002	001 002	001 002	001 002	001 002	001 002	001 002	001 002	001 002	001 002
	2	001 002	001 002	003 004	003 004	003 004	003 004	003 004	003 004	003 004	003 004
	3	001 002	001 002	001 002	001 002	005 006	005 006	005 006	005 006	005 006	005 006
	4	001 002	001 002	003 004	003 004	005 006	005 006	007 008	007 008	007 008	007 008
	5	001 002	001 002	003 004	003 004	005 006	005 006	007 008	007 008	009 010	009 010
	6	001 002	003 004	001 002	005 006	002 002	007 008	001 002	009 010	001 002	011 012
	7	001 002	003 004	003 004	007 008	003 004	009 010	003 004	011 012	003 004	013 014
	8	001 002	003 004	001 002	005 006	005 006	011 012	005 006	013 014	005 006	015 016
	9	001 002	003 004	003 004	007 008	005 006	011 012	007 008	015 016	007 008	017 018
	10	001 002	003 004	003 004	007 008	005 006	011 012	007 008	015 016	009 010	019 020
	11	001 002	005 006	001 002	009 010	001 002	013 014	001 002	017 018	001 002	021 022
	12	001 002	005 006	003 004	011 012	003 004	015 016	003 004	019 020	003 004	023 024
	13	001 002	005 006	001 002	009 010	005 006	017 018	005 006	021 022	005 006	025 026
	14	001 002	005 006	003 004	011 012	005 006	017 018	007 008	023 024	007 008	027 028
	15	001 002	005 006	003 004	011 012	005 006	017 018	007 008	023 024	009 010	029 030
	16	001 002	007 008	001 002	013 014	001 002	019 020	001 002	025 026	001 002	031 032
	17	001 002	007 008	003 004	015 016	003 004	021 022	003 004	027 028	003 004	033 034
	18	001 002	007 008	001 002	013 014	005 006	023 024	005 006	029 030	005 006	035 036
	19	001 002	007 008	003 004	015 016	005 006	023 024	007 008	031 032	007 008	037 038
	20	001 002	007 008	003 004	015 016	005 006	023 024	007 008	031 032	009 010	039 040
	21	001 002	009 010	001 002	017 018	001 002	025 026	001 002	033 034	001 002	041 042
	22	001 002	009 010	003 004	019 020	003 004	027 028	003 004	035 036	003 004	043 044
	23	001 002	009 010	001 002	017 018	005 006	029 030	005 006	037 038	005 006	045 046
	24	001 002	009 010	003 004	019 020	005 006	029 030	007 008	039 040	007 008	047 048
	25	001 002	009 010	003 004	019 020	005 006	029 030	007 008	039 040	009 010	049 050

Mode		DIM		CT		RGB		RGBW		RGBCW	
		CH01	CH08	CH02	CH16	CH03	CH24	CH04	CH32	CH05	CH40
Address quantity		2	16	4	32	6	48	8	64	10	80
Resolution		16bit	16bit	16bit	16bit	16bit	16bit	16bit	16bit	16bit	16bit
Channels	26	001 002	011 012	001 002	021 022	001 002	031 032	001 002	041 042	001 002	051 052
	27	001 002	011 012	003 004	023 024	003 004	033 034	003 004	043 044	003 004	053 054
	28	001 002	011 012	001 002	021 022	005 006	035 036	005 006	045 046	005 006	055 056
	29	001 002	011 012	003 004	023 024	005 006	035 036	007 008	047 048	007 008	057 058
	30	001 002	011 012	003 004	023 024	005 006	035 036	007 008	047 048	009 010	059 060
	31	001 002	013 014	001 002	025 026	001 002	037 038	001 002	049 050	001 002	061 062
	32	001 002	013 014	003 004	027 028	003 004	039 040	003 004	051 052	003 004	063 064
	33	001 002	013 014	001 002	025 026	005 006	041 042	005 006	053 054	005 006	065 066
	34	001 002	013 014	003 004	027 028	005 006	041 042	007 008	055 056	007 008	067 068
	35	001 002	013 014	003 004	027 028	005 006	041 042	007 008	055 056	009 010	069 070
	36	001 002	015 016	001 002	029 030	001 002	043 044	001 002	057 058	001 002	071 072
	37	001 002	015 016	003 004	031 032	003 004	045 046	003 004	059 060	003 004	073 074
	38	001 002	015 016	001 002	029 030	005 006	047 048	005 006	061 062	005 006	075 076
	39	001 002	015 016	003 004	031 032	005 006	047 048	007 008	063 064	007 008	077 078
	40	001 002	015 016	003 004	031 032	005 006	047 048	007 008	063 064	009 010	079 080

Work with RDM editor

D40 can work with LTECH RDM editor (Model: WiFi-RDM01) to realize changing the parameters by long-range setting, wiring diagram as below:

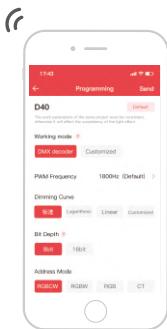
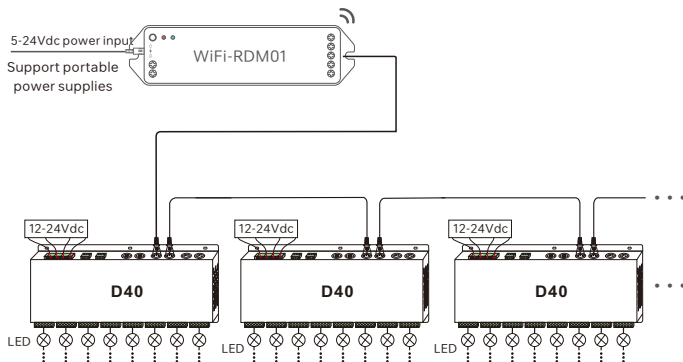

RDM editor App interface instruction

Download the App, setting the D40 parameters (frequency, bit, curve, modes, dimming range, screensaver, etc.) after well connecting the RDM editor, more details, please check the manual of WiFi-RDM01.

Well installation of products first, then working with WiFi -RDM01 to realize setting parameters and firmware upgrade by App.

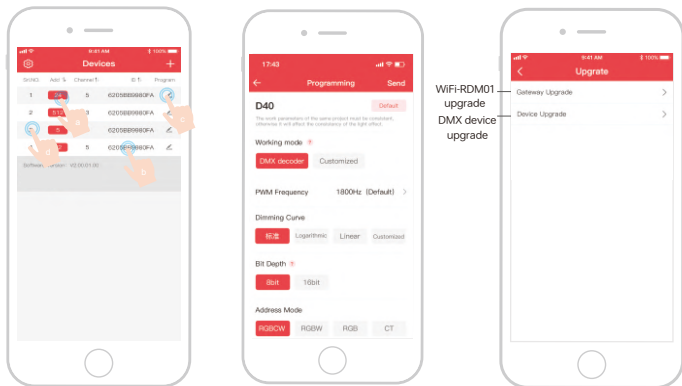

WiFi-RDM01
upgrade
DMX device
upgrade

- Click "Add", edit the address in corresponding box.
- Click "ID", get more product details.
- Click "✎", enter edited interface.
- Click "No.", issue the recognizing command.

Supporting WiFi-RDM01 upgrade
and DMX driver upgrade.

Attention

- Product installation and commissioning should be done by a qualified professional.
- Our company products are and not lightningproof non-waterproof(special models excepted). Please avoid the sun and rain. When installed outdoors, please ensure they are mounted in a waterproof enclosure or in an area equipped with lightning protection devices.
- Good heat dissipation will prolong the working life of products. Please ensure good ventilation.
- Please check if the working voltage used complies with the parameter requirements of products.
- The diameter of wire used must be able to load the light fixtures you connect and ensure the firm wiring.
- Before you power on products, please make sure all the wiring is correct in case of incorrect connection that causes damage to light fixtures.
- If a fault occurs, please do not attempt to fix products by yourself. If you have any question, please contact your suppliers.

Warranty Agreement

- Warranty periods from the date of delivery: 5 years.
- Free repair or replacement services for quality problems are provided within warranty periods.

Warranty exclusions below:

Following conditions are not within the guarantee range of free repairing or replacement services:

- Beyond warranty periods.
 - Any artificial damage caused by high voltage, overload, or improper operations.
 - Products with severe physical damage.
 - Damage caused by natural disasters and force majeure.
 - Warranty labels and barcodes have been damaged.
 - No any contract signed by our company.
1. Repair or replacement provided is the only remedy for customers. Our company is not liable for any incidental or consequential damage unless it is within the law.
 2. Our company has the right to amend or adjust the terms of this warranty, and release in written form shall prevail.
- * This manual is subject to changes without further notice. Product functions depend on the goods. Please feel free to contact our official distributors if you have any question.